

**PRODUCT SPECIFICATIONS**

Sensor Type	Submersible Tension Link Load Cell
Sensor Part Number	3400FTL-20K
Full Scale Capacity (FS)	20,000 lbf
Full Scale Output	2.0 mV/V Nominal
Combined Error	≤ 0.25 % of FS
Zero Balance Signal	≤ 1.00% of FS
Input/Output Resistance	350 to 1,000 Ω Nominal
Excitation Voltage	2 to 24 V Max
Insulation to Ground	> 5 GΩ
Electrical Connection	MCBH4F Bulkhead Connector
Mating Cable	MCIL4M Connector with 4 Conductor Cable, 50' Long
Sensor Material	17-4 Stainless Steel
Operating Depth	< 3,500 ft (1,500 psi) Submerged
Safe Overload	150% of FS
Ultimate Overload	300% of FS
Calibration	NIST Traceable per ASTM E4, Certificate Provided
RoHS Compliant	Yes

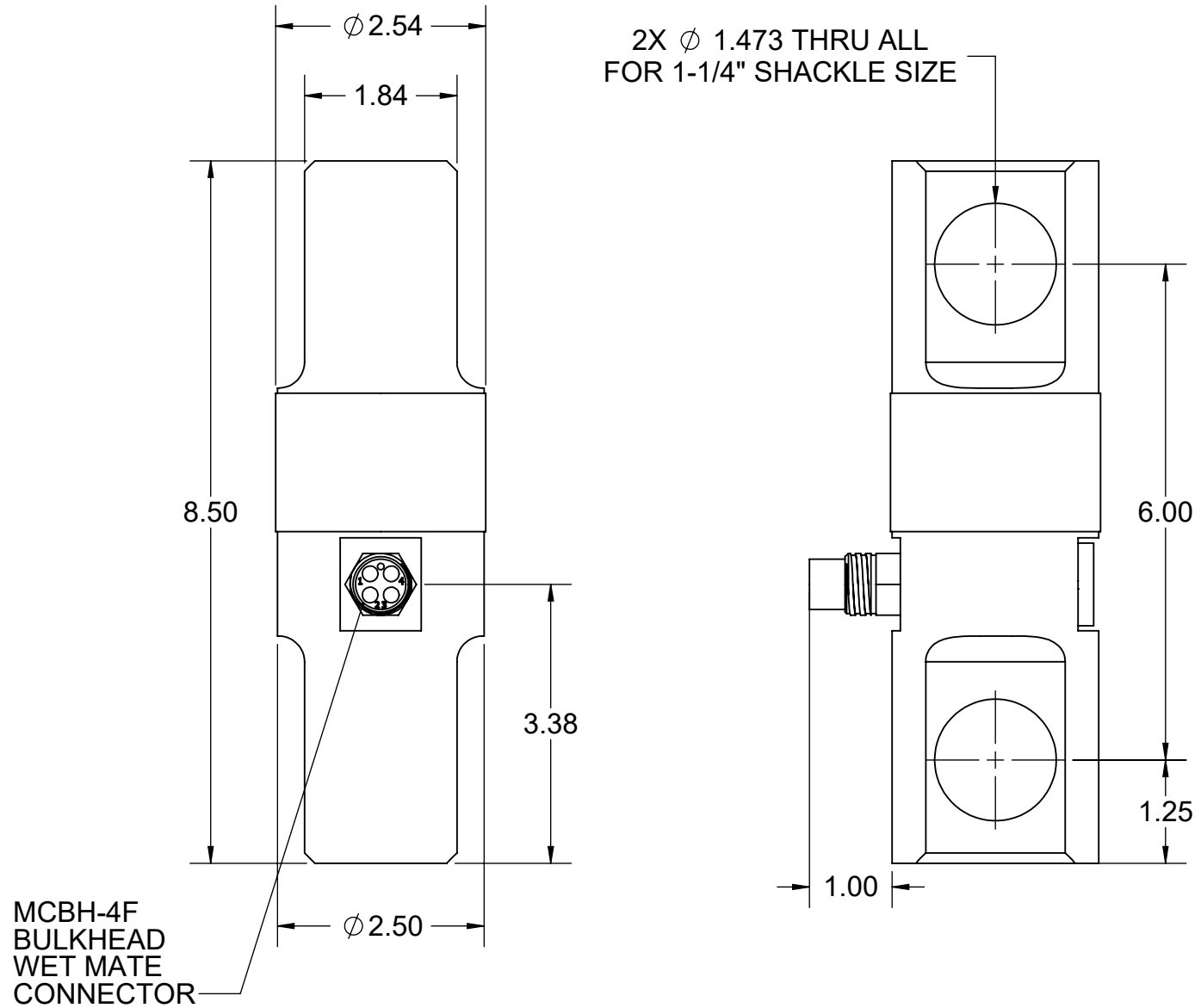

CUSTOM GEOMETRIES, CAPACITIES, DEPTH RATINGS & CONNECTORS AVAILABLE UPON REQUEST

CONTACT FACTORY FOR ANALOG OR DIGITAL SIGNAL CONDITIONING OPTIONS

CONFIRM CRITICAL DIMENSIONS WITH FACTORY PRIOR TO PLACING AN ORDER

UNLESS OTHERWISE STATED:  
THIRD ANGLE PROJECTION  
TOLERANCES:  
ANGULAR ±0.5 DEG  
0.X ±0.1 INCHES  
0.XX ±0.03 INCHES  
0.XXX ±0.005 INCHES

**SUBMERSIBLE TERNSION LINK  
LOAD CELL, 20,000 LBF,  
PRODUCT DRAWING**

<b>SENSING SYSTEMS CORPORATION</b> 7 COMMERCE WAY, DARTMOUTH, MA 02747 USA	3400FTL-20K	-
	SHEET 1 OF 1	REV